

2SC1213A

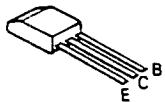

- 2SA640
- 2SA720A
- 2SA733
- 2SA872
- 2SA872A
- 2SC1318
- 2SC1318A

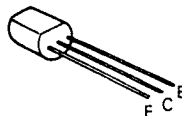

- 2SD525
- 2SD526
- 2SC1827

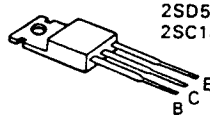

DC voltages to the chassis are ref

2SC1212A

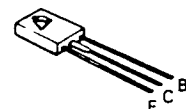

STEREO INTEGRATED AMPLIFIER

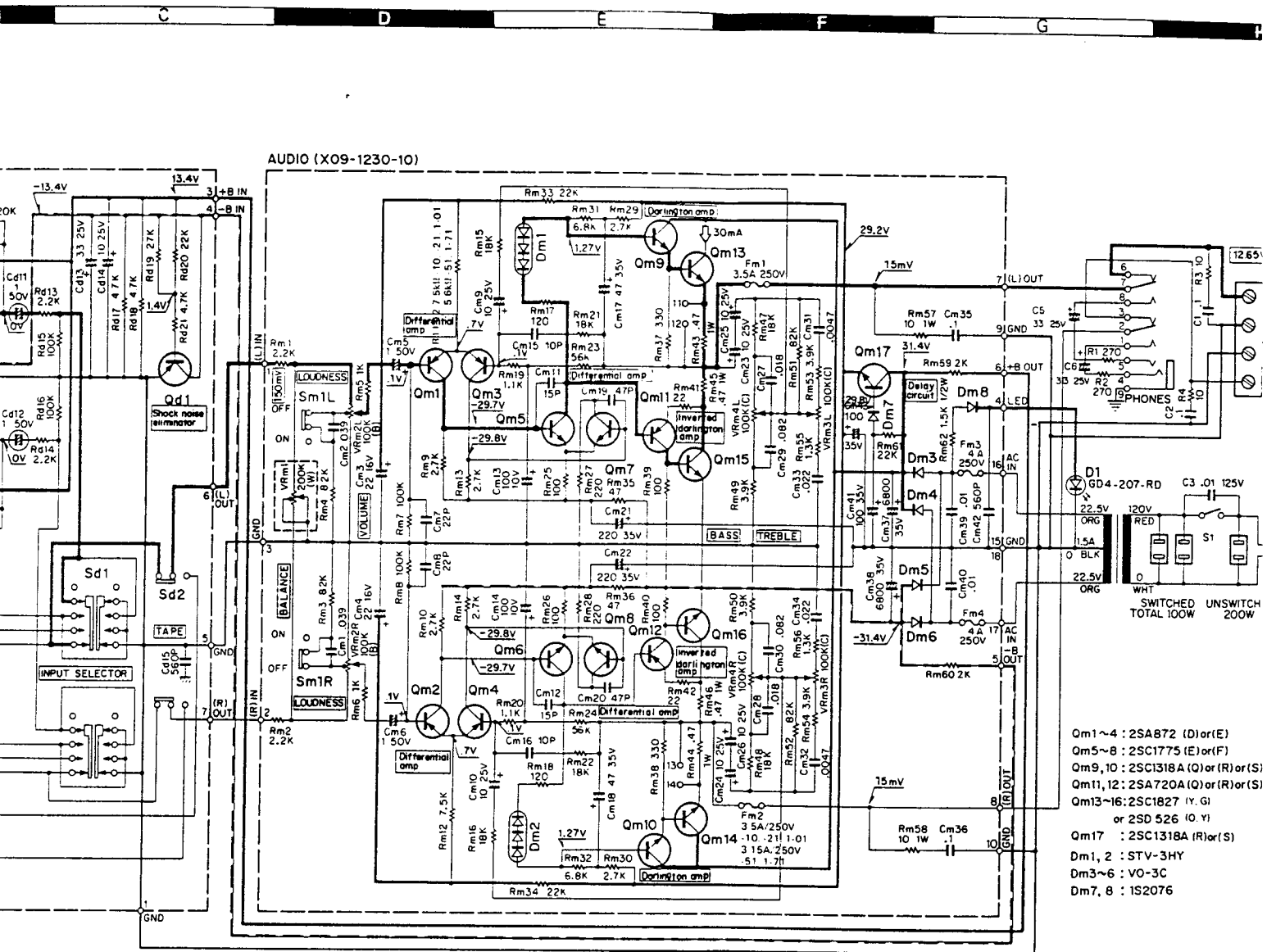

- Qm1~4 : 2SA872 (D) or (E)
- Qm5~8 : 2SC1775 (E) or (F)
- Qm9, 10 : 2SC1318A (Q) or (R) or (S)
- Qm11, 12 : 2SA720A (Q) or (R) or (S)
- Qm13~16 : 2SC1827 (Y, G) or 2SD 526 (O, Y)
- Qm17 : 2SC1318A (R) or (S)
- Dm1, 2 : STV-3HY
- Dm3~6 : VO-3C
- Dm7, 8 : 1S2076

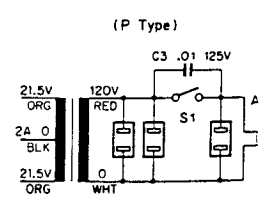
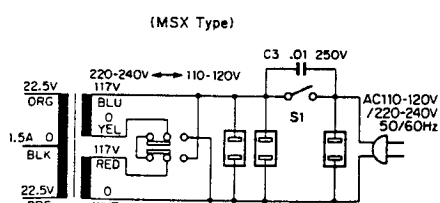
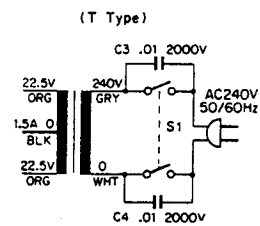

KA-37C

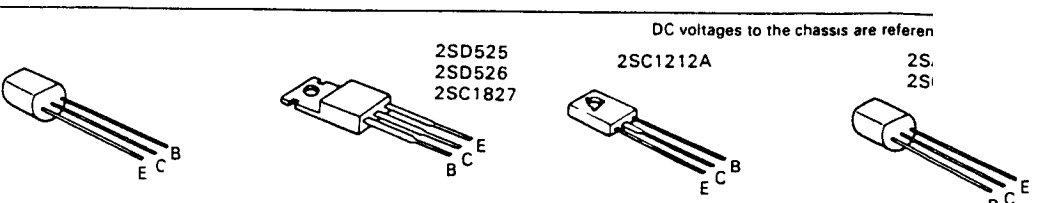

with a 20 kΩ/V circuit tester under no sh

or	Substitution	Semiconductor
2SA872	2SA850	2SC1318A
2SC1213A	2SA640	2SC1775
2SC1318	2SA872A	2SC1827
	2SC1212A	2SD526
	2SC1318A	
	2SC1212A	

(KA-3750) KA-3700

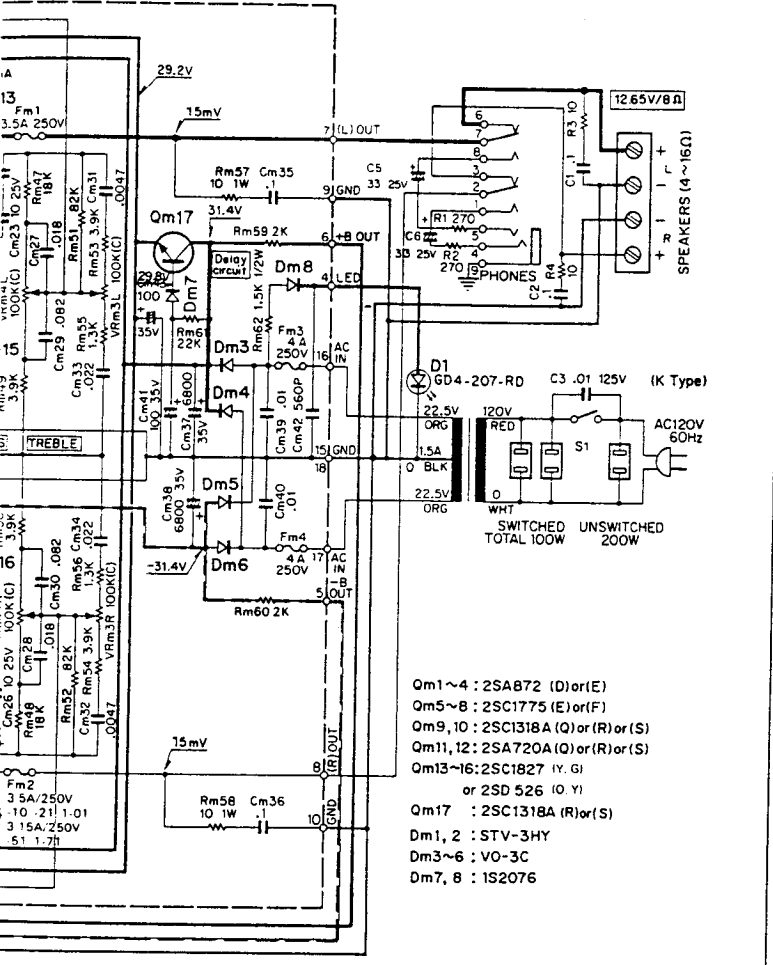
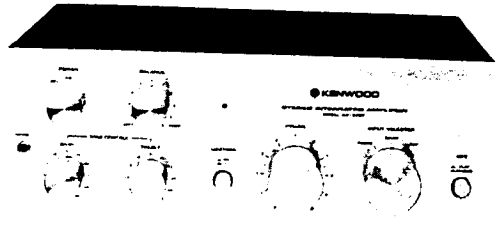

- Qm1~4 : 2SA872 (D) or (E)
- Qm5~8 : 2SC1775 (E) or (F)
- Qm9, 10 : 2SC1318A (Q) or (R) or (S)
- Qm11, 12 : 2SA720A (Q) or (R) or (S)
- Qm13~16 : 2SC1827 (Y, G) or 2SD 526 (O, Y)
- Qm17 : 2SC1318A (R) or (S)
- Dm1, 2 : STV-3HY
- Dm3~6 : VO-3C
- Dm7, 8 : 1S2076

(MSX Type)

(P Type)

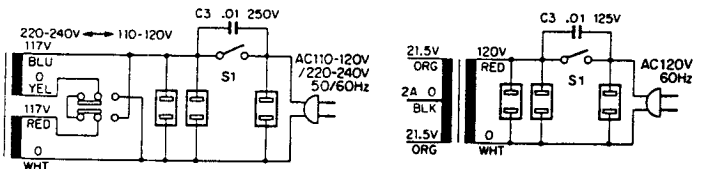

KA-3700(K)

Reference values obtained from measurements with a 20 kΩ/V circuit tester under no signal condition.

2SA850
2SC1735

Semiconductor	Substitution	Semiconductor	Substitution
2SA720A	2SA850	2SC1318A	2SC1735
2SA733	2SA640	2SC1775	2SC1775A
2SA872	2SA872A	2SC1827	2SD525
2SC1213A	2SC1212A	2SD526	2SD525
2SC1318	2SC1318A		
	2SC1212A		

Power Output (K·M·S·X)
20 watts* per channel, minimum RMS at 8 ohms from 20 Hz to 20,000 Hz with no more than 0.08% total harmonic distortion.

Power Output (W·L·T)
25 watts per channel, minimum RMS at 8 ohms from 20 Hz to 20,000 Hz with no more than 0.1% total harmonic distortion.

- Both Channel Driven (K·M·S·X)**
22 + 22 watts 4 ohms at 1,000 Hz
- Both Channel Driven (W·L·T)**
25 + 25 watts 4 ohms at 1,000 Hz
- Dynamic Power Output**
100 watts 4 ohms
- Total Harmonic Distortion (K·M·S·X)**
0.08% at rated power into 8 ohms
- Total Harmonic Distortion (W·L·T)**
0.1% at rated power into 8 ohms
- Total Harmonic Distortion**
0.04% at 1/2 rated power into 8 ohms
- Intermodulation Distortion**
0.04% at rated power into 8 ohms (60 Hz : 7 kHz = 4 : 1)
- Power Bandwidth**
10 Hz at 50 kHz
- Damping Factor**
30 at 8 ohms
- Speaker Impedance**
Accept 4 ohms to 16 ohms
- Input Sensitivity/Impedance**
 - Phono 2.5 mV/50k ohms
 - Tuner 150 mV/10k ohms
 - AUX 150 mV/50k ohms
 - Tape 150 mV/50k ohms
- Signal to Noise Ratio (IHF, A)**
 - Phono 72 dB for 2.5 mV input
78 dB for 5.0 mV input
84 dB for 10 mV input
 - Tuner 100 dB for 150 mV input
 - AUX 100 dB for 150 mV input
 - Tape 100 dB for 150 mV input

- Maximum Input Level for**
 - Phono 150 mV (rms), T.H.D 0.08% at 1,000 Hz
- Output Level/Impedance**
Tape REC (Pin) 140 mV/450 ohms
- Frequency Response**
 - Phono RIAA standard curve +0.4 dB, -0.4 dB
 - AUX and Tape 20 Hz to 20 kHz +1 dB, -1 dB

- Tone Control**
 - Bass ± 7.5 dB at 100 Hz
 - Treble ± 7.5 dB at 10 kHz
- Loudness Control**
9 dB at 100 Hz (at -30 dB Volume Level)

- Power Consumption**
185 watts at full power
- A.C. Outlet**
Switched 2, Unswitched 1
- Dimension**
 - W 14-31/32" (380 mm)
 - H 5-1/2" (140 mm)
 - D 11-7/18" (291 mm)
- Weight (Net)**
12.7 lbs (5.7 kg)
- (Gross)**
15.2 lbs (6.8 kg)

* Measured pursuant to Federal Trade Commission's Trade Regulation rule on Power Output Claims for Amplifier in U.S.A.

Note:
Kenwood follows a policy of continuous advancements in development. For this reason specifications may be changed without notice.